

HYD52 COMPRESSION DRIVER



MAGNET	STRONTIUM FERRITE
POWER	40W RMS 80W MAX
FREQUENCY	1.2KHz TO 20KHz
THROAT	1" DIAMETER
Imp	8 OHM
S.P.L	106dB
VOICE COIL	44.4mm
WEIGHT	1.7Kg

HYD53 COMPRESSION DRIVER



MAGNET	STRONTIUM FERRITE
POWER	80W RMS 160W MAX
FREQUENCY	1.0KHz TO 20KHz
THROAT	1" DIAMETER
Imp	8 OHM
S.P.L	108dB
VOICE COIL	51.6mm
WEIGHT	3.0Kg

HD001 HORN DRIVER



PIEZO	22mm DUAL LAYER
POWER	50W RMS
FREQUENCY	1K5 - 22K Hz
THROAT	1" DIAMETER
Imp	8 OHM
S.P.L	98dB

HD004 HORN DRIVER



PIEZO	22mm DUAL LAYER
POWER	80W RMS
FREQUENCY	1K5 - 22K Hz
THROAT	1" DIAMETER
Imp	8 OHM
S.P.L	98dB

HYD-9 COMPRESSION DRIVER



MAGNET	110mm
POWER	45W RMS 90W MAX
FREQUENCY	800 - 14000 Hz
THROAT	1" DIAMETER
Imp	8 OHM
S.P.L	103dB
VOICE COIL	38mm

HD60 HORN: SPEAKER DRIVER



THROAT	1" DIAMETER
POWER	60W RMS
FREQUENCY	300 Hz TO 5000Hz
S.P.L	103dB
Imp	8 OHM
VOICE COIL	COPPER
VOICE COIL	50mm
DIMENSION	110mm

HYD-14A SUPER TWEETER



MAGNET	70x32x10
POWER	100W MAX
FREQUENCY	1K - 20K Hz
S.P.L	98dB
Imp	4 OHM
DIMENSIONS	120 X 100 mm
VOICE COIL	25.4 mm

HYD-20 SUPER TWEETER



MAGNET	90x45x15
POWER	200W MAX
FREQUENCY	1.5K - 20K Hz
S.P.L	103dB
Imp	8 OHM
DIMENSIONS	100 X 100 mm
VOICE COIL	45 mm



LH612

外形尺寸	320X151X210mm
Size	320X151X210mm

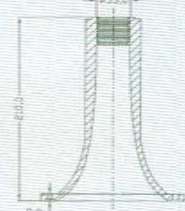
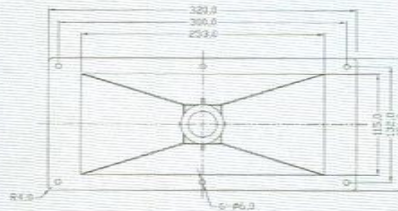

LH1675

Size	420X160X220mm
------	---------------

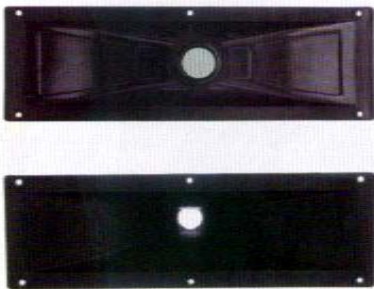
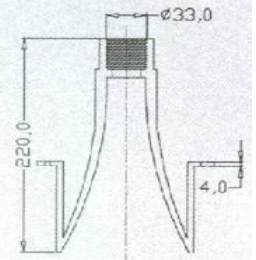
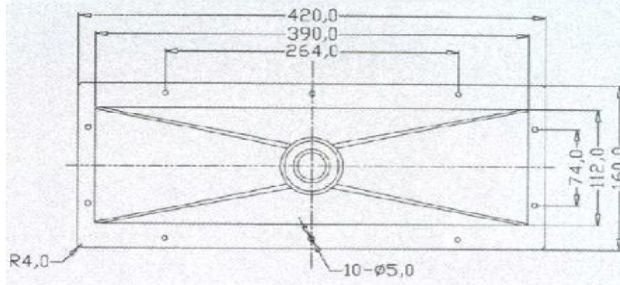

HN515

Size	387X130X156mm
------	---------------

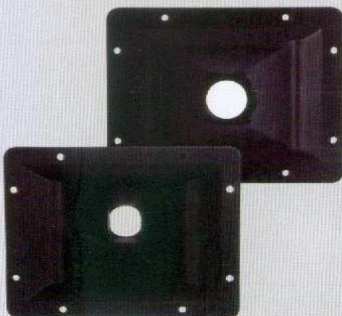
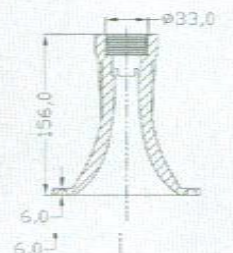
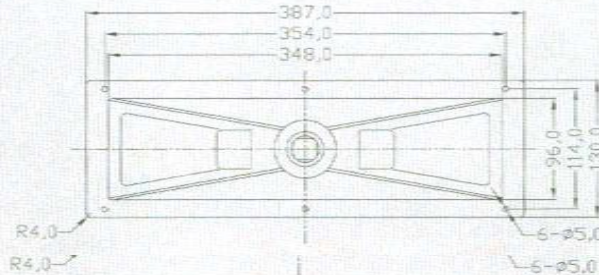

HN607

Size	197X156X114mm
------	---------------

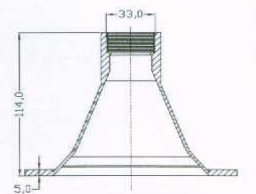
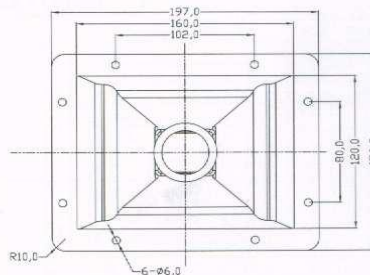

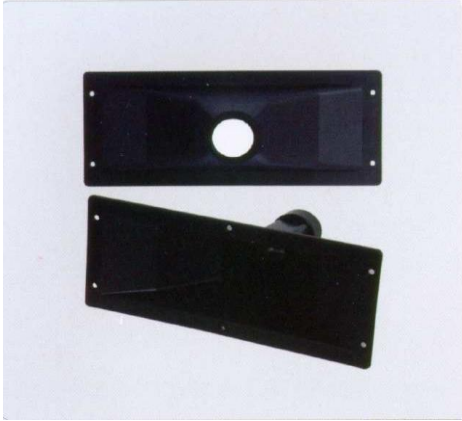

HN337

Size	265X110X170mm
------	---------------

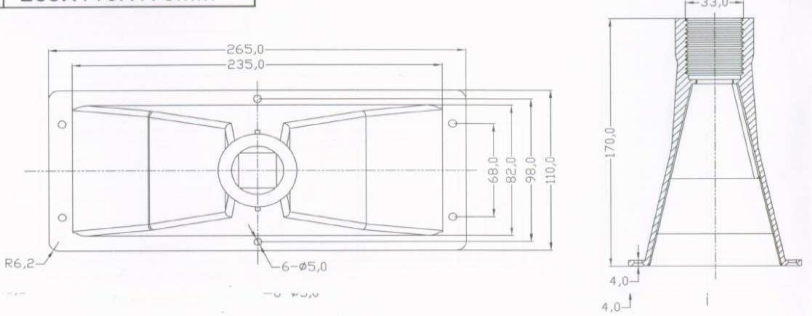



HYD4

TYPE	MAGNETIC 80mm
POWER MAX	40W RMS
FREQUENCY	1K Hz TO 17K Hz
S.P.L	105dB
IMP	4 - 16 Ohm
DIMENSIONS	125mm OD
VOICE COIL	25.4mm DIA



HYD5

TYPE	MAGNETIC 80mm
POWER MAX	40W RMS
FREQUENCY	1K Hz TO 17K Hz
S.P.L	105dB
IMP	4 - 16 Ohm
DIMENSIONS	110mm
VOICE COIL	25.4mm DIA

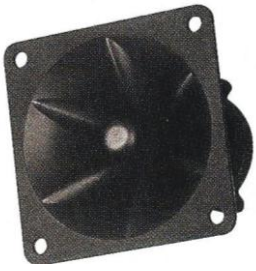

HT307

TYPE	PIEZO
POWER MAX	150W
FREQUENCY	4 - 20K Hz
S.P.L	98dB
IMP	4 - 16 Ohm
DIMENSIONS	4" SQUARE



HT309

TYPE	PIEZO
POWER MAX	150W
FREQUENCY	4 - 20K Hz
S.P.L	98dB
IMP	4 - 16 Ohm
DIMENSIONS	4" ROUND



HT003
CAR PIEZO

CLIP ON BASE	
MAX POWER	150 WATT
FREQUENCY	4 - 20K Hz
S.P.L	98dB
IMPEDANCE	4 - 16 Ohm
DIMENSIONS	1.25"
	BLISTER PACK



HT003C
CAR PIEZO

ON STAND	
MAX POWER	150 WATT
FREQUENCY	4 - 20K Hz
S.P.L	98dB
IMPEDANCE	4 - 16 Ohm
DIMENSIONS	1.25"
	BLISTER PACK